

Metal Garden Shed

Plechový zahradní domek

Plechový záhradný domček

OWNER'S INSTRUCTION
NÁVOD NA MONTÁŽ
MONTÁŽNY NÁVOD

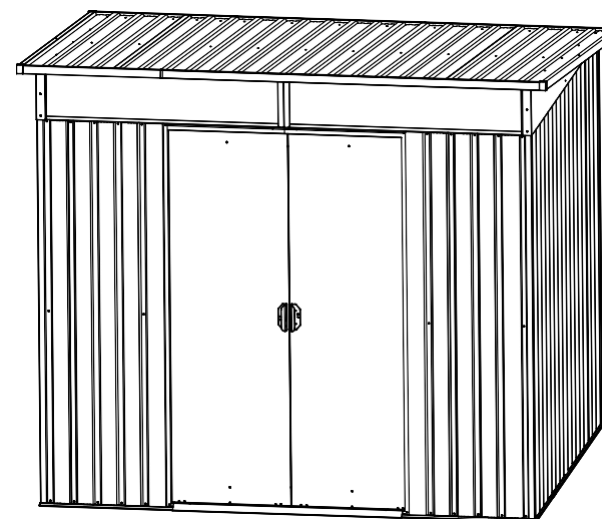

ZDSL-4A

- Requires two people and takes 4-8 hours for installation.
- Quick & Easy assembly
- Ridge reinforced walls
- Available in various sizes

- Stavba vyžaduje dvě až tři osoby a trvá cca 4-8 hodin (podle modelu).
- Rychlé a snadné sestavení.
- Kvalitní povrchová úprava.
- K dispozici v různých velikostech.
- Ideální pro uskladnění zahradních potřeb.

- stavba vyžaduje dve až tri osoby a trvá cca 4-8 hodín (podľa modelu)
- rýchle a jednoduché zostavenie
- kvalitná povrchová úprava
- k dispozícii v rôznych veľkostiach
- ideálne pre uskladnenie záhradných potrieb

BEFORE YOU START

Owner's Manual

Prior to installation, it is important that you contact your local government authority to determine if building approval is required. Study and understand this owner's manual. Important information and helpful tips will make your construction easier and more enjoyable.

Assembly instructions

Instructions are supplied in this manual and contain all appropriate information for your building model. Review all instructions before you begin. During assembly, follow the step sequence carefully for correct results .

Parts

Check to be sure that you have all the necessary parts for the building.

Separate contents of the carton by the part number while reviewing parts list.

Familiarize yourself with the hardware and fasteners for easier use during construction. These are packaged within the carton. Note that extra fasteners have been supplied for your convenience.

TOOLS MAY REQUIRED



M2.4&M5



5.5X7

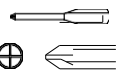
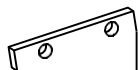

PH1

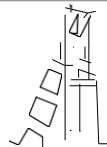
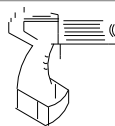

Use heavy duty gloves when handling steel sheets and flashing

PLAN AHEAD

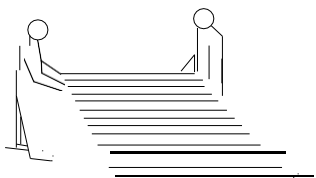

Watch the weather:

Please be sure the day you select for installation is dry and calm.

DO NOT attempt to assemble your shed in windy weather because of risk of damage to panels, or personal injury. Be careful of wet or muddy ground.

Teamwork:

Whenever possible, two or more people should work together to assemble the building. One person can position parts or panels while the other is able to handle the fasteners and the tools.

PLAN AHEAD

Site Selection

- Avoid overhanging trees as much as possible as leaves will make regular cleaning necessary and broken branches are a potential hazard.
- Small trees, bushes or fences nearby can be helpful, acting as a wind break.

Site Preparation

The site must be prepared so that the base of the shed is level all round and checking with a spirit level is required.

The base can be constructed by treated timber or concrete, in order to stop the moisture getting into the shed. **The shed is not designed to be built onto lawn directly.** Also the ground will get muddy during rainy days.

If a concrete pad is made, it is important that this slopes towards the edges to prevent water ingress.

Time must be allowed for any concrete or cement to dry before building the shed on top.

Bases can also be constructed from bricks, blocks, or mounted on a concrete pad.

The bricks or blocks should be cemented onto firm and level concrete footings and the greenhouse frame drilled and screwed to the base.

IMPORTANT NOTES:

- Find someone to help you: it is much easier with someone to hold parts, pass tools ect. Also some steps require two people to lift structures together. This is not very heavy work so would suit most able-bodied people.
- Allow plenty of time: rushing often causes errors and the re-doing of incorrect assemblies. If you have never built a shed before, it can take most of a day to carefully complete the construction.
- Have the right tools to hand.
- Safety clothing as recommended in the 'Tools' section.
- Ideally lay out the parts and check that all are present before commencing construction. Lay on cloths or plastic sheets if there is any risk of scratching the parts.
- Tighten all nuts carefully, being sure not to miss any. Check the frame is square and using a spirit level to check that it is upright.

PŘED ZAČÁTKEM STAVBY

Před stavbou

Před instalací doporučujeme kontaktovat místní úřady, abyste zjistili, zda je stavba domku se všemi předpisy. Před zahájením stavby si pečlivě přečtěte tento návod. Důležité informace a užitečné tipy vám ulehčí a zpříjemní stavbu. Tento domek není určen pro bydlení, ale pro ukládání věcí.

Montážní návod

Pokyny v této příručce obsahují všechny potřebné informace pro stavbu vašeho modelu domku. Před zahájením si přečtěte všechny pokyny. Během montáže postupujte opatrně a v pořadí podle posloupnosti jednotlivých kroků. **Důležité upozornění: Tento domek stavte minimálně ve dvou osobách, stavba by měla trvat přibližně den.**

Díly

- Zkontrolujte, zda máte všechny potřebné součásti domku.
- Pečlivě zkontrolujte i menší drobnější díly domku.
- **Pokud cokoliv chybí, tak domek NESTAVTE a kontaktujte nás.**

DOPORUČENÉ NÁŘADÍ

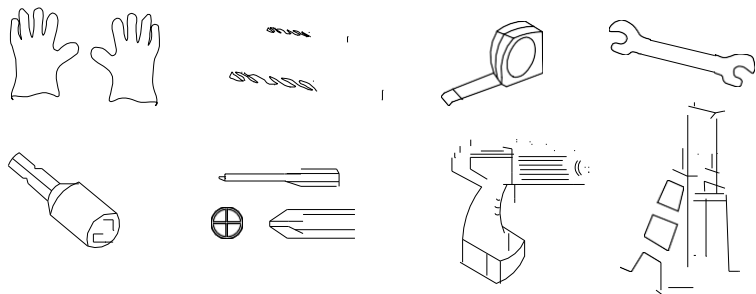

Při manipulaci s ocelovými plechy používejte silné rukavice

VŠE PROMYSLETE

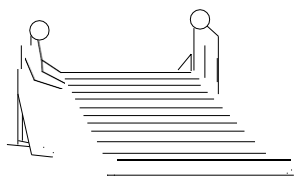

Dva lidé a jeden den práce.

ZVAŽTE POČASÍ:

Ujistěte se, že den, který vyberete pro instalaci, bude suchý a klidný. Nepokoušejte se sestavovat budovu za větrného počasí kvůli riziku poškození panelů nebo zranění osob. Dávejte pozor na vlhkou nebo blátivou půdu.

Týmová práce:

Stavbu domku by měly provádět dvě osoby. Jedna osoba může připevňovat díly domku a druhá je bude podávat a přidržovat. Domek nelze sestavit v jedné osobě.

CZ

PROMYŠLENÝ PLÁN

Základní pokyny

- Nestavte domek na větrném místě!
- **Domek musí být VŽDY pevně ukotven k zemi.**
- Nestavte domek pod převisy stromů, domek pak bude znečištěn listím. Padající větve představují také potencionální nebezpečí. Naopak menší keře v okolí zajistí ochranu domku před větrem.
- Nestavte domek za nepříznivého počasí (v bouřce, dešti, ve větru apod.).
- Domek nestavte, pokud jste unaveni, ani pod vlivem alkoholu.
- **Používejte ochranné pomůcky a vhodné nářadí.**
- Vždy dodržujte místní předpisu ohledně menších (drobných) staveb.
- Zabraňte přístupu dětí i domácích zvířat na stavbu. Hrozí nebezpečí poranění.
- Při stavbě se o domek neopírejte, ani jej nijak nepřesouvejte.
- Nelezte na střechu domky, ani na střeše nikdy nestůjte.

Příprava staveniště

- Místo pro domek musí být připraveno tak, aby základna domku byla v rovině. Zkontrolujte vodováhu!!
- Domek postavte na rovnou plochu z dlaždic, betonu nebo ze dřeva tak, aby se zabránilo vniknutí vlhkosti do domku. Domek není navržen tak, aby byl postaven přímo na trávník. Počítejte s jarními a podzimními plískanicemi.
- Pokud stavíte domek na betonové ploše, tak je důležité, aby se u okraje lehce směřovala směrem vně domku, aby se zabránilo vniknutí vody. Před stavbou domku je důležité, aby byla základní deska suchá (beton, dlaždice, cihly).
- Základy na domek je ideální postavit na dřevěné konstrukci postavené na zemních vrstech.

DŮLEŽITÉ POKYNY / DOPORUČENÍ :

- **Najděte si šikovného pomocníka.** Stavba je mnohem snazší, když se najde někdo, kdo vám přidrží jednotlivé části domku nebo jinak pomůže. Některé montážní kroky přímo vyžadují dva lidi. Ideální je stavba domku ve třech lidech.
- Na stavbu domku si nechte dostatek času a nespěchejte. Spěch způsobuje chyby a můžete zbytečně opakovat některé montážní kroky. Pokud jste nikdy předtím podobný domek nestavěli, tak může trvat celý den než stavbu dokončíte.
- Rozložte na ploše jednotlivé díly a zkontrolujte, že nic nechybí. Pokud něco chybí, tak stavbu **NEZAHAJUJTE** ! Dejte pozor na poškrábání dílů domku.
- Pečlivě utáhněte všechny matice! Zkontrolujte, zda je půdorys domku čtvercový a zda podložní plocha vodorovná.
- V domku neskladujte horké věci (např. rozpálený zahradní gril nebo sekačku).
- Pravidelně kontrolujte ukotvení domku
- V zimě pravidelně odstraňujte sníh ze střechy. **Doporučujeme před zimou dodatečně podepřít hřeben domku vhodnou podpěrrou.** Domek není konstruován na větší přívaly sněhu.
- Domek má odolnost vůči větru max. 70 km / hod.
- Při větru musí být dveře a případně i okna domku zavřeny a pevně zajištěny.
- Udržujte posuvný mechanismus dveří v čistotě, 1x ročně jej namažte silikonem olejem.
- Chraňte domek před průnikem povrchové i spodní vlhkosti.
- Domek čistěte výhradně mýdlem a vodou, nepoužívejte jiná chemická čisticíidla ani agresivní čisticí prostředky.

CZ

PRED ZAČÁTKOM STAVBY

SK

Pred stavbou

Pred inštaláciou odporúčame kontaktovať miestne úrady, aby ste zistili, či je stavba domčeka so všetkými predpismi. Pred začatím stavby si starostlivo prečítajte tento návod. Dôležité informácie a užitočné tipy vám uľahčí a spríjemní stavbu. Tento domček nie je určený pre bývanie, ale pre ukladanie vecí.

Montážny návod

Pokyny v tejto príručke obsahujú všetky potrebné informácie pre stavbu vášho modelu domčeka. Pred začatím prečítajte všetky pokyny. Počas montáže postupujte opatrne a v poradí podľa postupnosti jednotlivých krokov. Dôležité upozornenie: Tento domček stavajte minimálne v dvoch osobách, stavba by mala trvať približne deň.

Diely

- Skontrolujte, či máte všetky potrebné súčasti domčeka.
- Starostlivo skontrolujte aj menšie drobnejšie diely domčeka.
- Ak čokoľvek chýba, tak domček NESTAVAJTE a kontaktujte nás.

ODPORÚČANÉ NÁRADIE

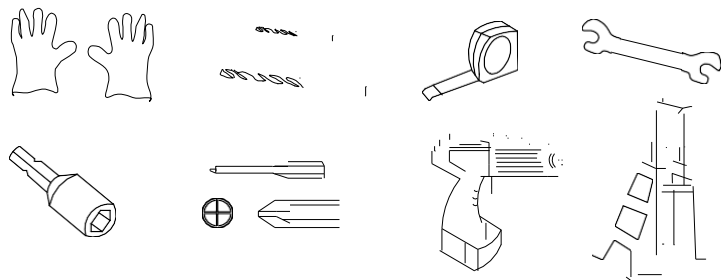

Pri manipulácii s ocelovými plechmi používajte hrubé rukavice

PREMYSLENÝ PLÁN

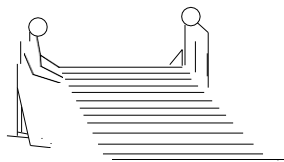

VÝBER POČASIA PRE MONTÁŽ:

Uistite sa, že deň, ktorý vyberiete pre inštaláciu, bude suchý a pokojný. Nepokúšajte sa zostavovať budovu za veterného počasia kvôli riziku poškodenia panelov alebo zraneniu osôb. Dávajte pozor na vlhku alebo blatovej pôde.

TÝMOVÁ PRÁCA:

Stavbu domčeka by mali vykonávať dve osoby. Jedna osoba môže pripievňovať diely domčeka a druhá ich bude podávať a pridržovať. Domček nemožno zostaviť v jednej osobe.

Uvaja tuatia a jaeen aen prace.

PREMYSLENÝ PLÁN

SK

Základné pokyny

- Nestavajte domček na veternom mieste!
- Domček musí byť VŽDY pevne ukotvený k zemi.
- Nestavajte domček pod prevismi stromov, domček potom bude znečistený lístím a lišajníkmi. Padajúce konáre predstavujú tiež potenciálnu nebezpečenstvo. Naopak menšie kríky v okolí zabezpečí ochranu domčeka pred vetrom.
- Nestavajte domček za nepriaznivého počasia (v búrke, daždi, vo vetre a pod.).
- Domček nestavajte, ak ste unavení, ani pod vplyvom alkoholu.
- **Používajte ochranné pomôcky a vhodné náradie.**
- Vždy dodržujte miestne predpisu ohľadom menších (drobných) stavieb.
- Zabráňte prístupu detí i domácich zvierat na stavbu. Hrozí nebezpečenstvo poranenia.
- Pri stavbe sa o domček neopierajte, ani ho nijako nepresúvajte.
- Nelezte na strechu domčeka, ani na streche nikdy nestojte.



Príprava staveniska



- Miesto pre domček musí byť pripravené tak, aby základňa domčeka bola v rovine. Skontrolujte vodováhou !!
- Domček postavte na rovnú plochu z dlaždíc, betónu alebo z dreva tak, aby sa zabránilo vniknutiu vlhkosti do domčeka. Domček nie je navrhnutý tak, aby bol postavený priamo na trávnik. Počítajte s jarnými a jesennými čľapkanicami.
- Ak staviate domček na betónovej ploche, tak je dôležité, aby sa u okraja mierne zvažovala smerom zvonka domčeka, aby sa zabránilo vniknutiu vody. Pred stavbou domčeka je dôležité, aby bola základná doska suchá (betón, dlaždice, tehly).
- Základy na domček je ideálne postaviť na drevenej konštrukcii postavené na zemných skrutkách.

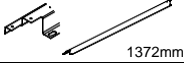
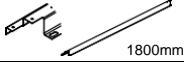
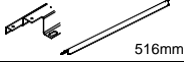
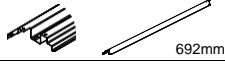
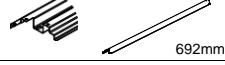
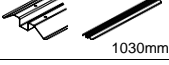
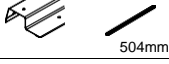
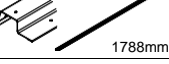
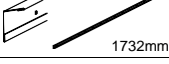
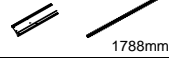
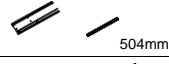
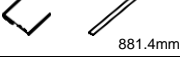
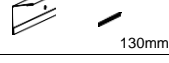
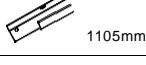
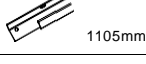
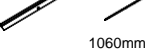

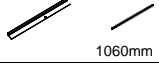
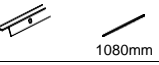
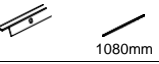
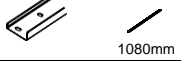
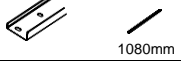
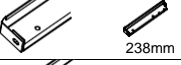
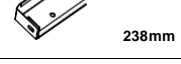
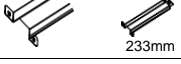

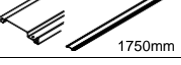
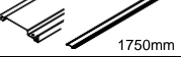
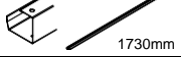
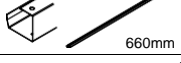
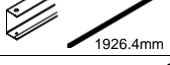
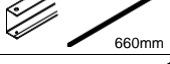
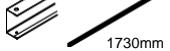
DÔLEŽITÉ POKYNY / ODPORÚČANIE:

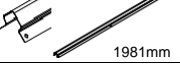
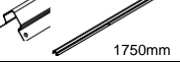
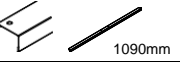

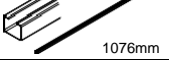
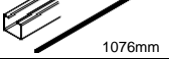
- Nájdite si šikovného pomocníka. Stavba je oveľa ľahšia, keď sa nájde niekto, kto vám pridrží jednotlivé časti domčeka alebo inak pomôže. Niektoré montážne kroky priamo vyžadujú dvoch ľudí. Ideálne je stavba domčeka v troch ľuďoch.
- Na stavbu domčeka si nechajte dostatok času a neponáhľajte. Spech spôsobuje chyby a môžete zbytočne opakovať niektoré montážne kroky. Ak ste nikdy predtým podobný domček nestavali, tak môže trvať celý deň ako stavbu dokončíte.
- Rozložte na ploche jednotlivé diely a skontrolujte, že nič nechýba. **Ak niečo chýba, tak stavbu nezačínajte!** Dajte pozor na poškrabanie dielov domčeka.
- Starostlivo utiahnite všetky matice! Skontrolujte, či je pôdorys domčeka štvorcový a či je podložná plocha vodorovná.
- V domčeku neskladujte horúce veci (napr. rozpálený záhradný gril alebo kosačku).
- **Pravidelne kontrolujte ukotvenie domčeka !!**
- **V zime pravidelne odstraňujte sneh zo strechy. Odporúčame pred zimou dodatočne podprieť hrebeň domčeka vhodnú podperou. Domček nie je konštruovaný na väčšie prívaly snehu.**
- Domček má odolnosť voči vetru max. 70 km / hod.
- Pri vetre musia byť dvere a prípadne aj okná domčeka zatvorené a pevne zaistené !!
- Udržujte posuvný mechanizmus dverí v čistote, 1x ročne ho namažte silikón. olejom.
- Chráňte domček pred prienikom povrchovej i spodnej vlhkosti !!
- Domček čistite výhradne mydlom a vodou, nepoužívajte iná chemická čistidlá ani agresívne čistiace prostriedky.

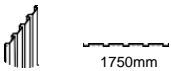



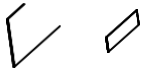

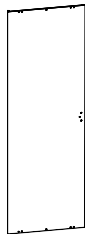



no. / číslo	diagram / díl / díel	qty/množství / množstvo
1	 1372mm	2
2	 1800mm	1
1-1	 516mm	3
3L	 692mm	1
3R	 692mm	1
5	 1030mm	1
9-1	 504mm	1
9	 1788mm	1
20	 1732mm	2
11	 1788mm	1
11-1	 504mm	1
11-2	 881.4mm	1
B1	 130mm	2
12L	 1105mm	1
12R	 1105mm	1
14L	 1060mm	1

no. / číslo	diagram / díl / díel	qty/množství / množstvo
14R	 1060mm	1
15L	 1080mm	1
15R	 1080mm	1
16L	 1080mm	1
16R	 1080mm	1
19L	 238mm	1
19R	 238mm	1
22	 233mm	2
18	 566mm	6
4L	 1750mm	1
4R	 1750mm	1
10	 1730mm	1
10-1	 660mm	1
17-2	 1926.4mm	2
17-1	 660mm	1
17	 1730mm	1

no. / číslo	diagram / díl / díel	qty/množství / množstvo
13	 1981mm	2
13-1	 1750mm	2
6	 1090mm	1
21L		1
21R		1
7L	 1076mm	1
7R	 1076mm	1

no. / číslo	diagram / díl / díel	qty/množství /množstvo
P1	 1750mm	15
P2	 1926.4mm	2
P3	 1926.4mm	3
P4	 1926.4mm	1
P5		2

no. / číslo	diagram / díl / díel	qty/množství /množstvo
D1	 1740X570mm	1
D2	 1740X570mm	1

no. / číslo	diagram / díl / díel	qty/množství /množstvo
G2		4
GD		4
GS		2
GB		2
GC		4
F1		310
F2		58
F3		8
S2		180
S3		252

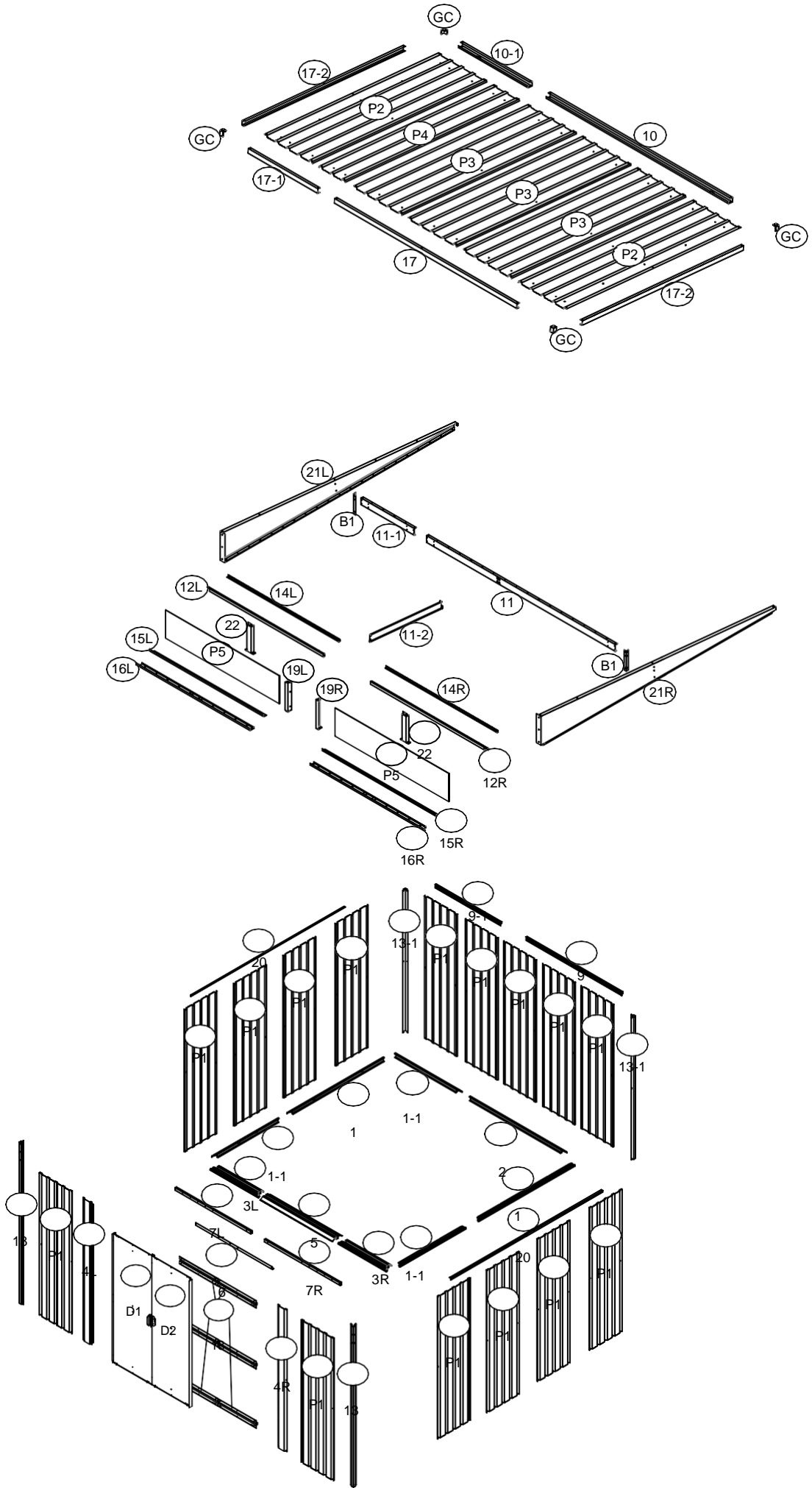

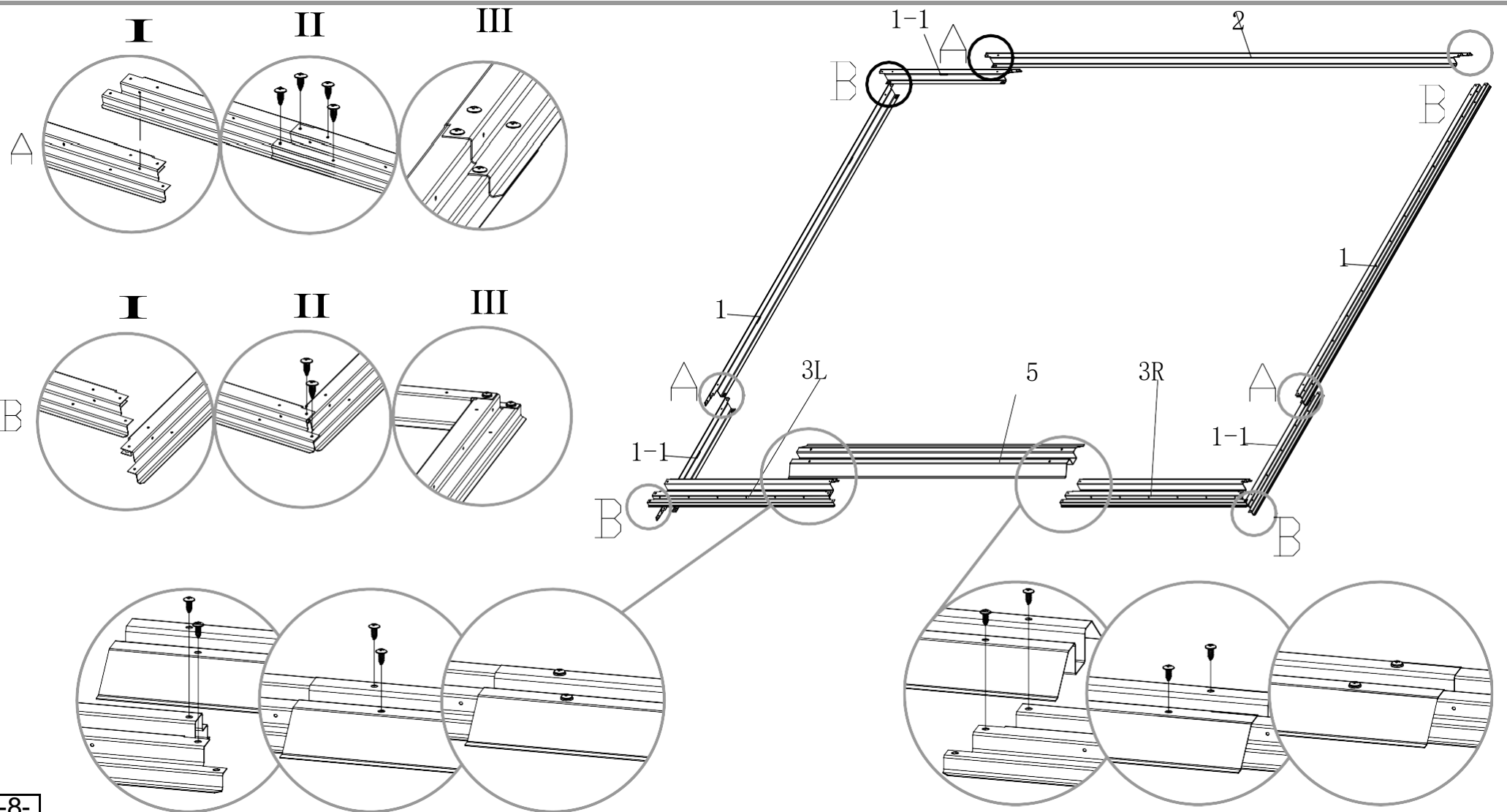
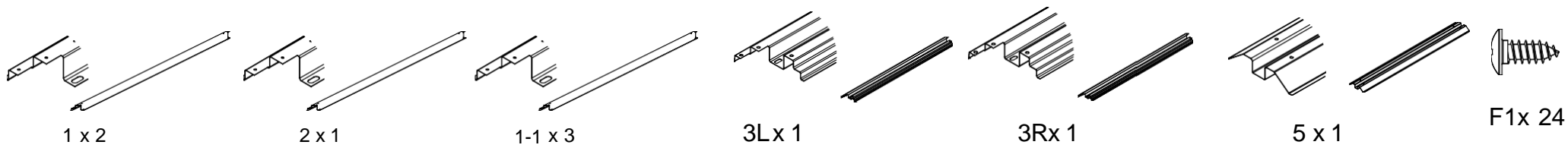

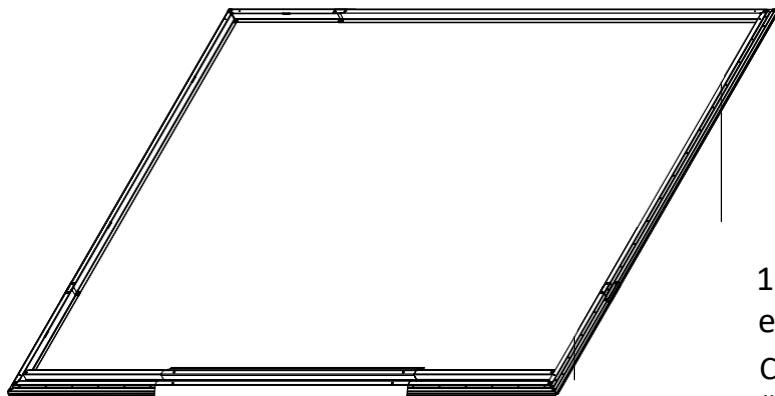

1、 When diagonal measurements are equal, the frame is square.

CZ - Pokud jsou úhlopříčky stejné, je rám čtvercový.

SK - Ak sú uhlopriečky rovnaké, je rám štvorcový.

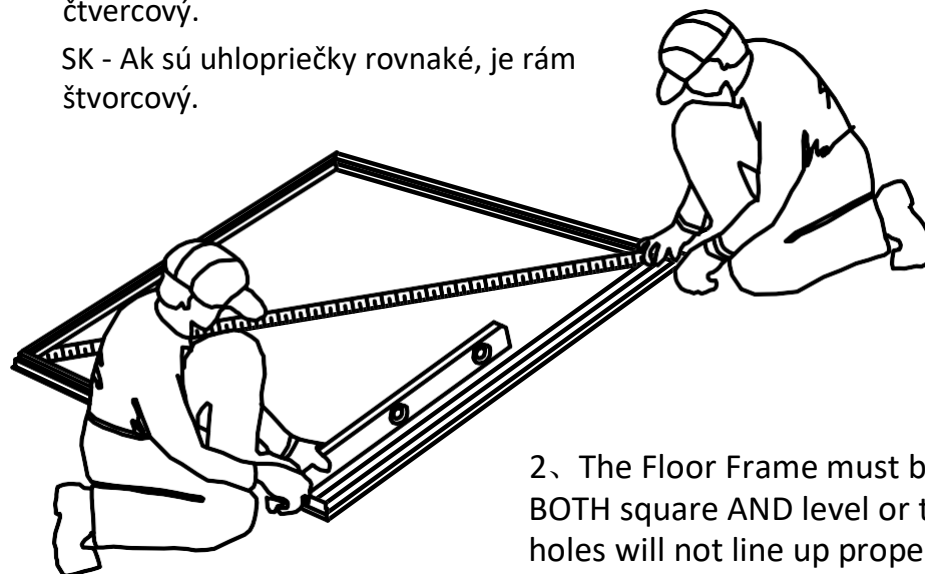

2、 The Floor Frame must be BOTH square AND level or the holes will not line up properly.

CZ - Podlahový rám musí být v rovině.

SK - Podlahový rám musí byť v rovine.

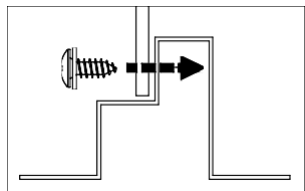
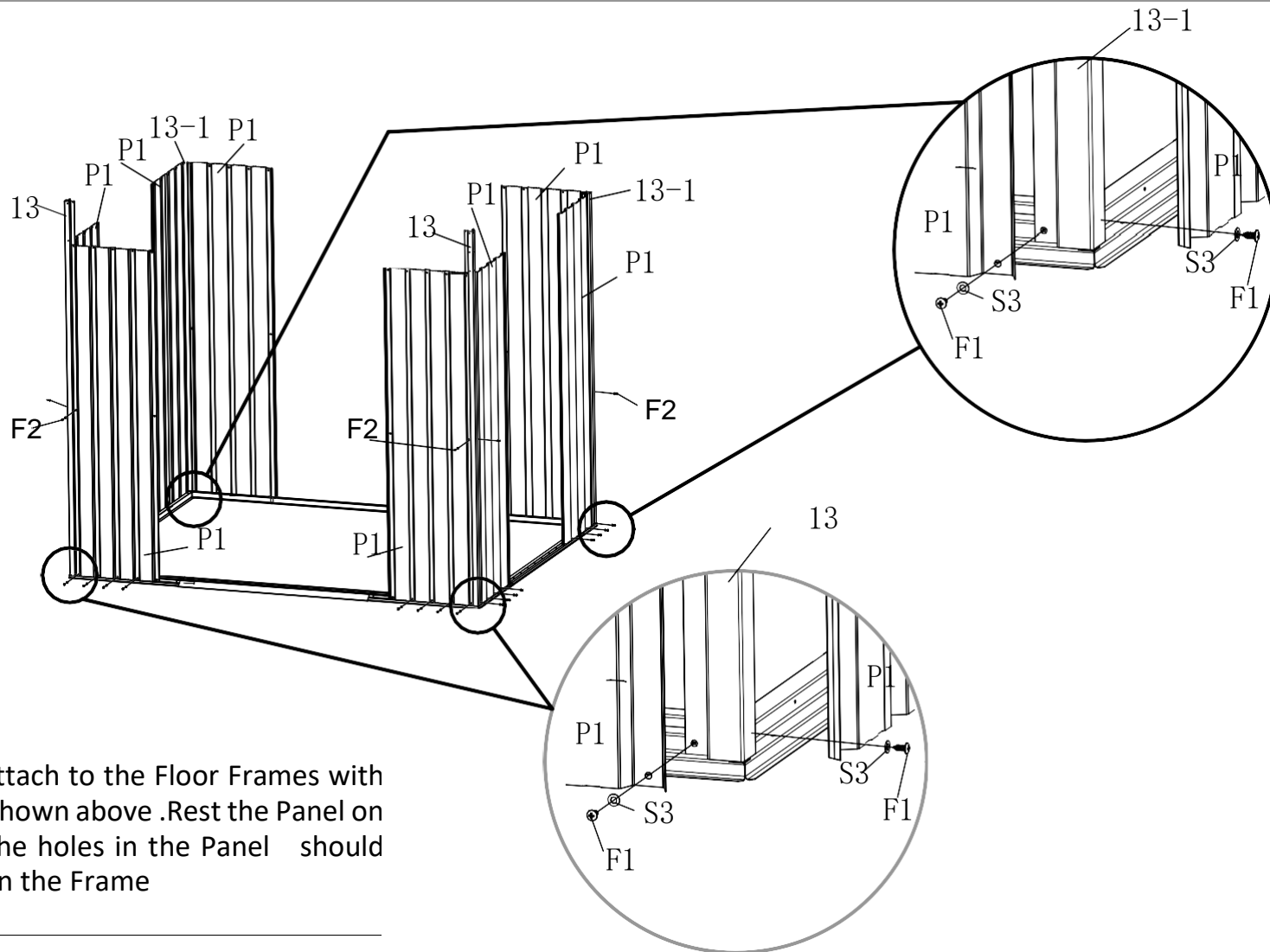
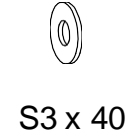
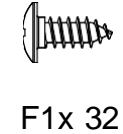
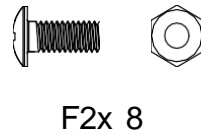
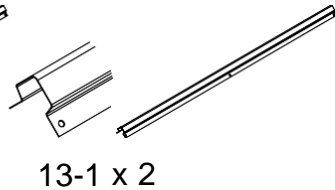
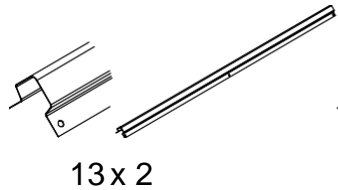
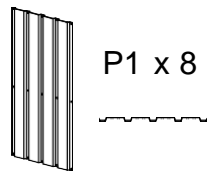

Wall panels ALWAYS attach to the Floor Frames with Screws in the manner shown above. Rest the Panel on the Floor Frame and the holes in the Panel should line up with the holes in the Frame

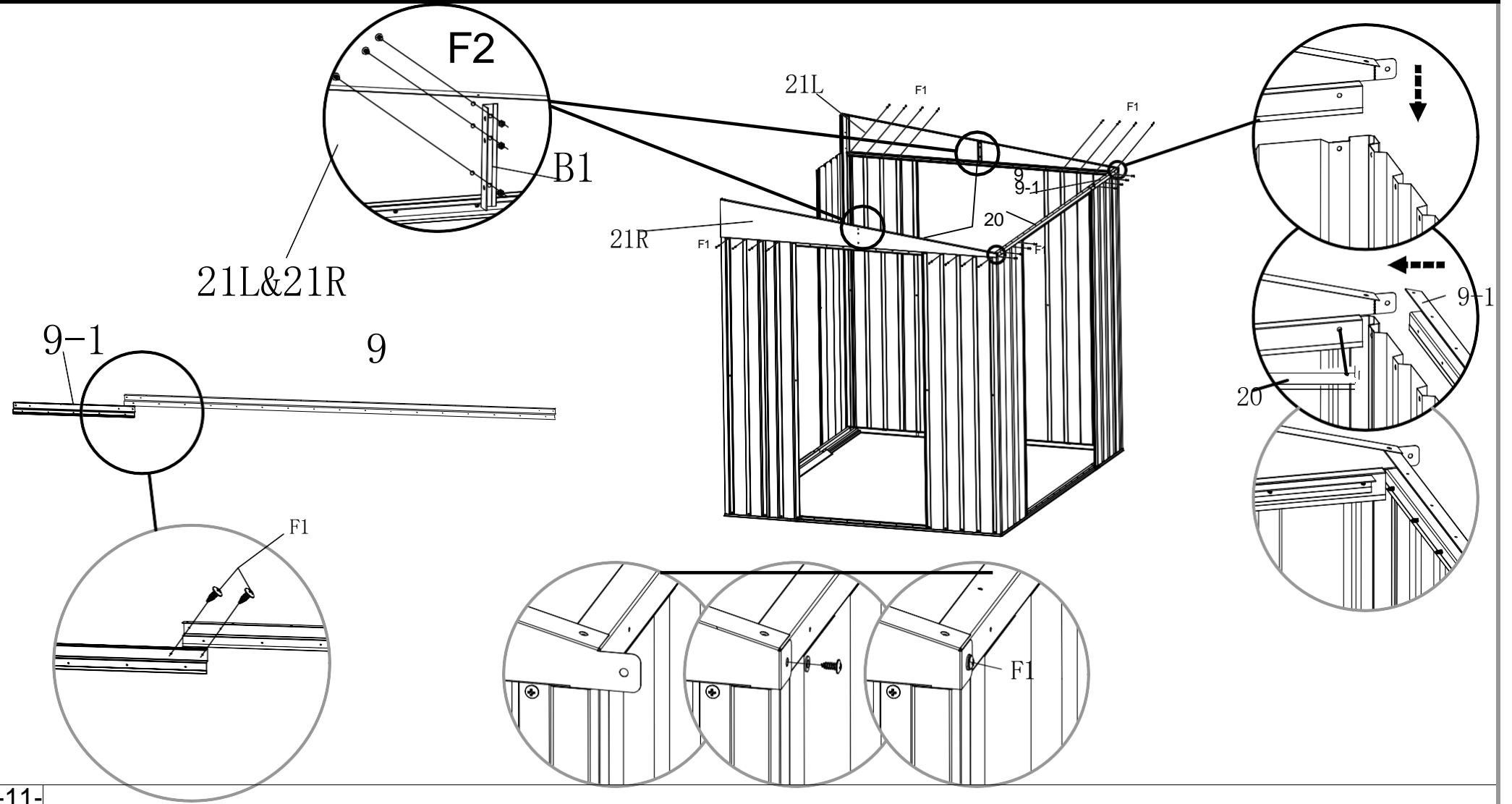
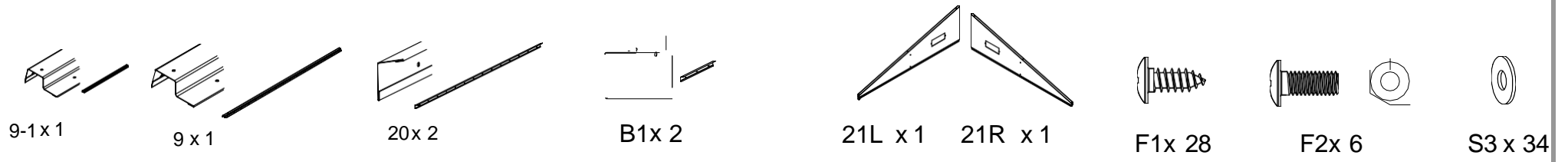



4L x 1



4R x 1

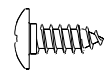

F1 x 4

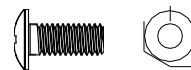

F2x 2



S3 x 6

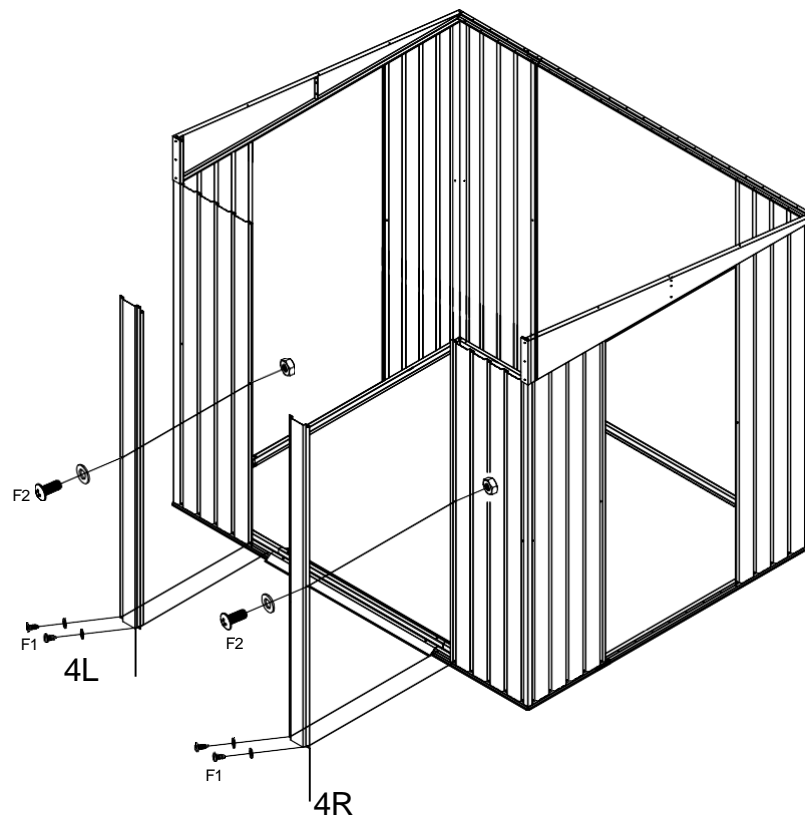

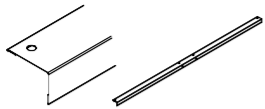

6 x 1



7Lx1



7Rx1

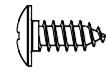

F1 x 2



S3 x 2

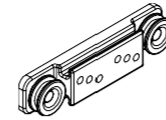

G2 x 4

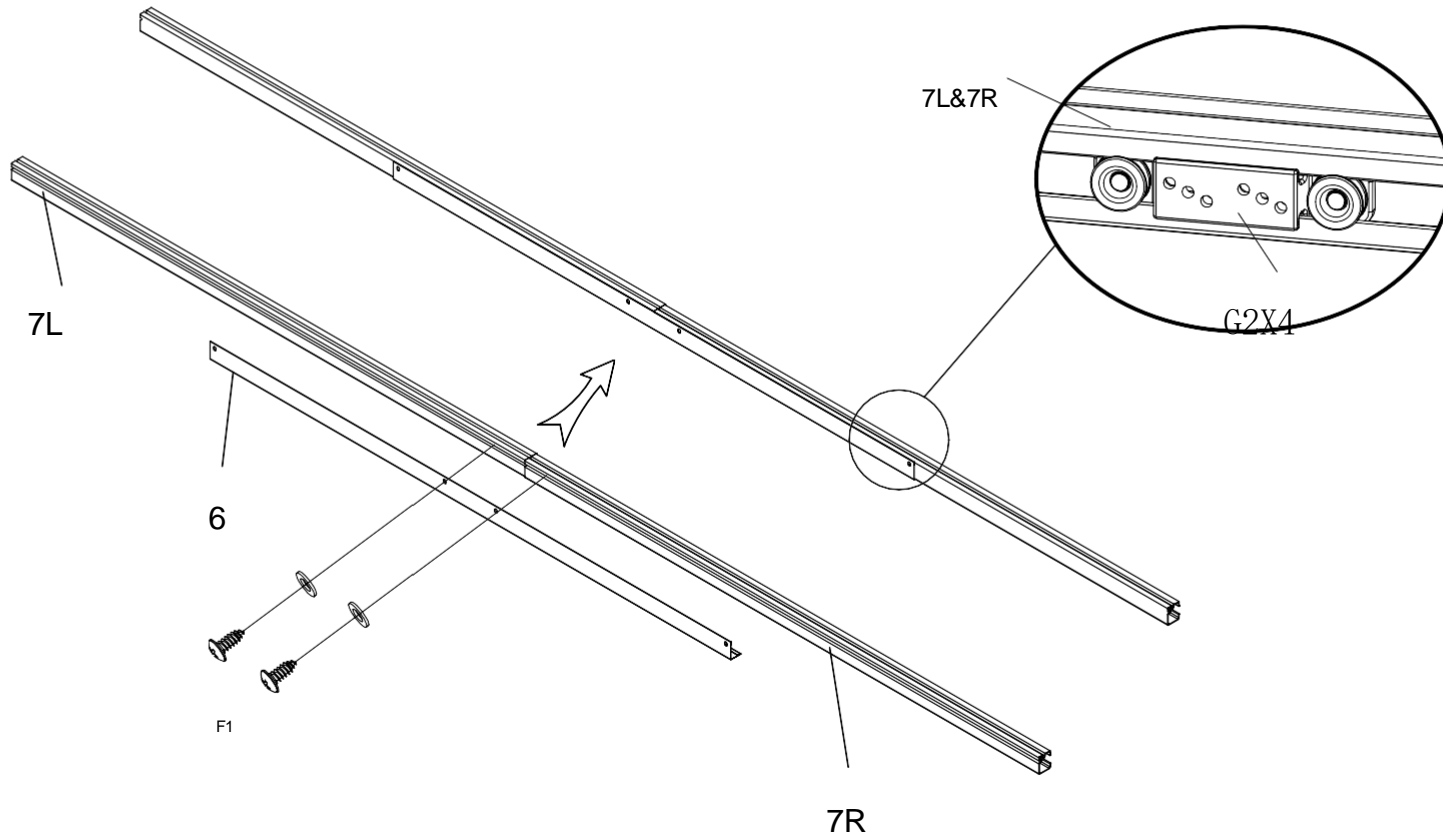

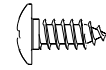

F1 x 12



S3 x 12

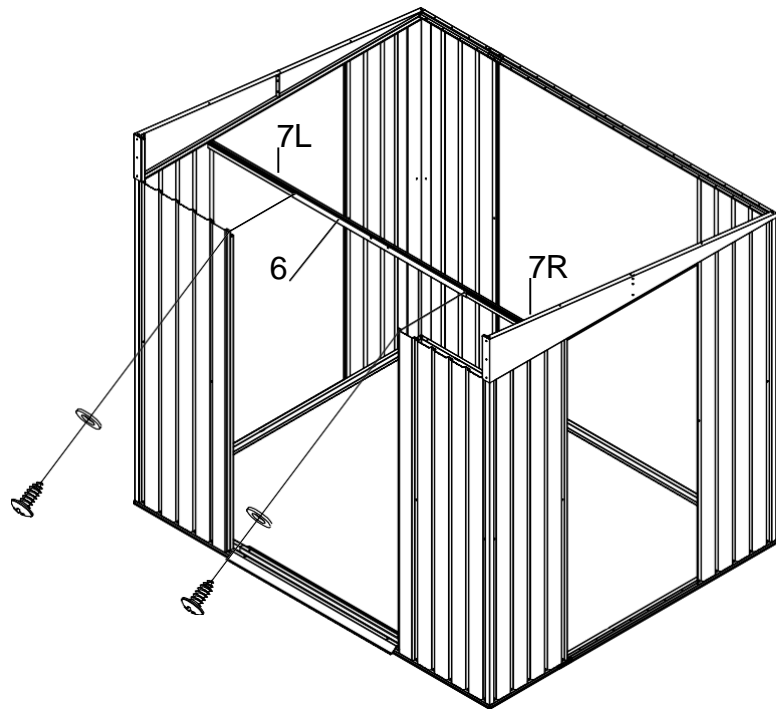

I

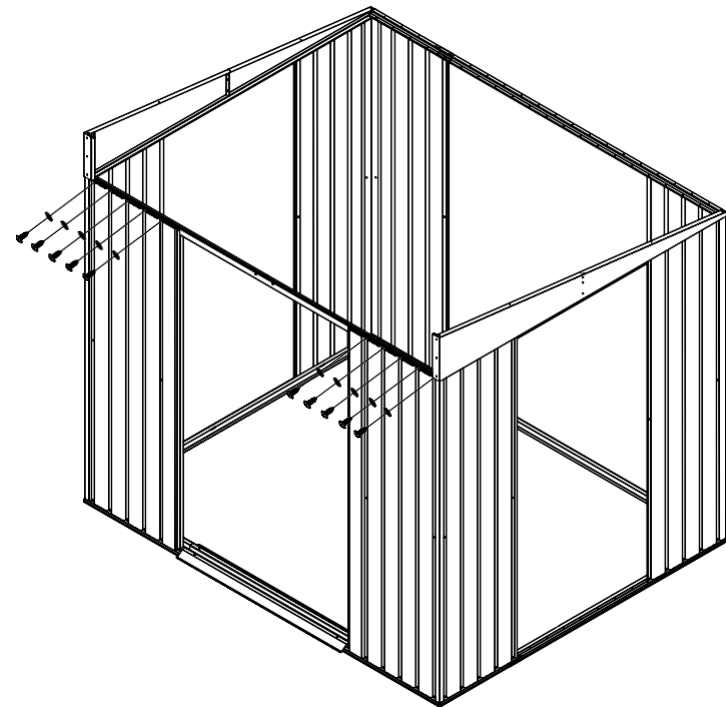

II

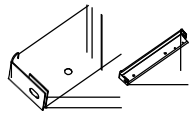

19Rx 1

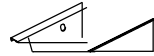

15Rx 1

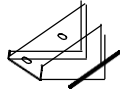

16Rx 1

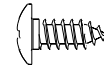

F1 x 1

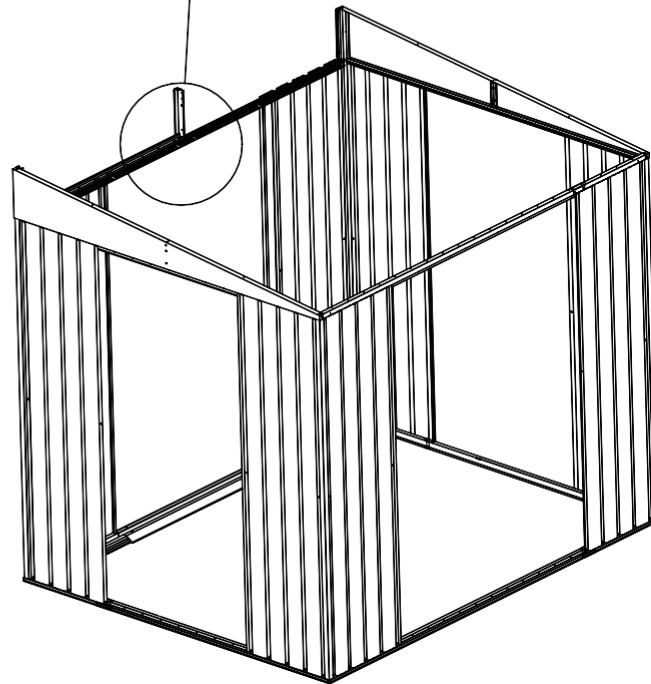
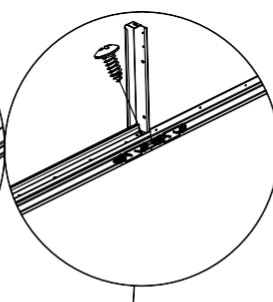
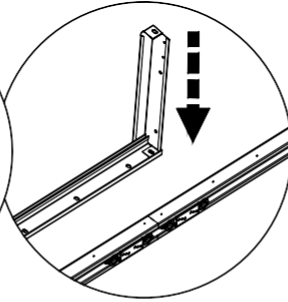
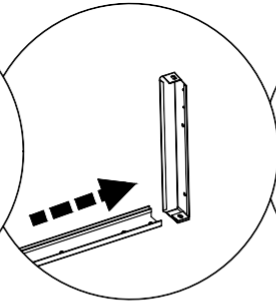
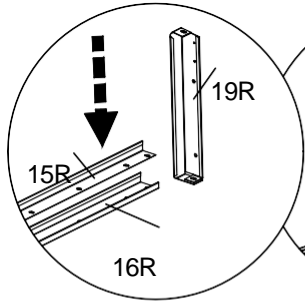

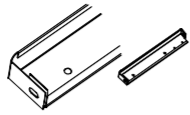

19L x 1

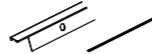

15L x 1

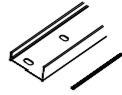

16L x 1

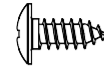

F1 x 1

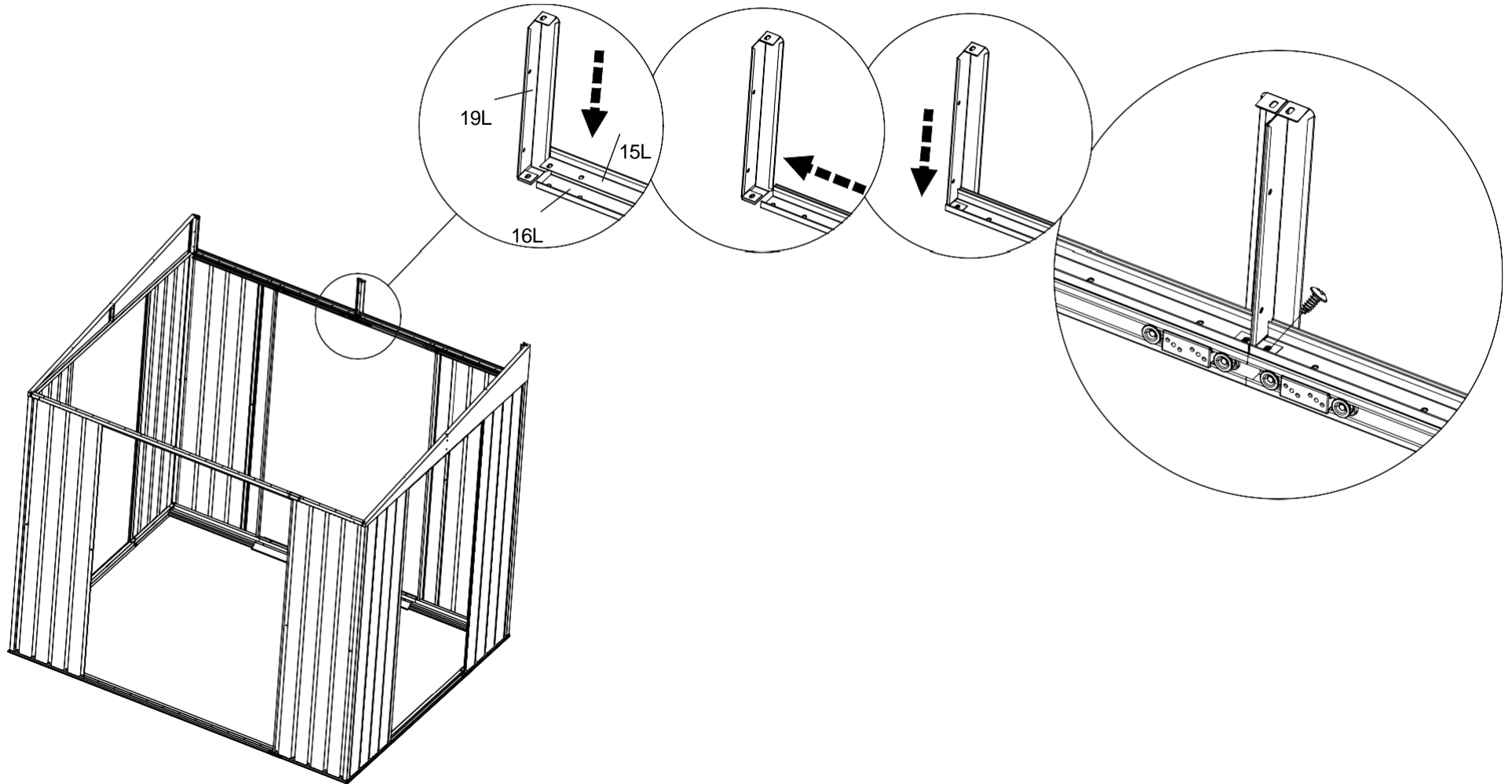

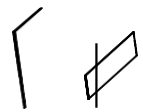

P5 x 2

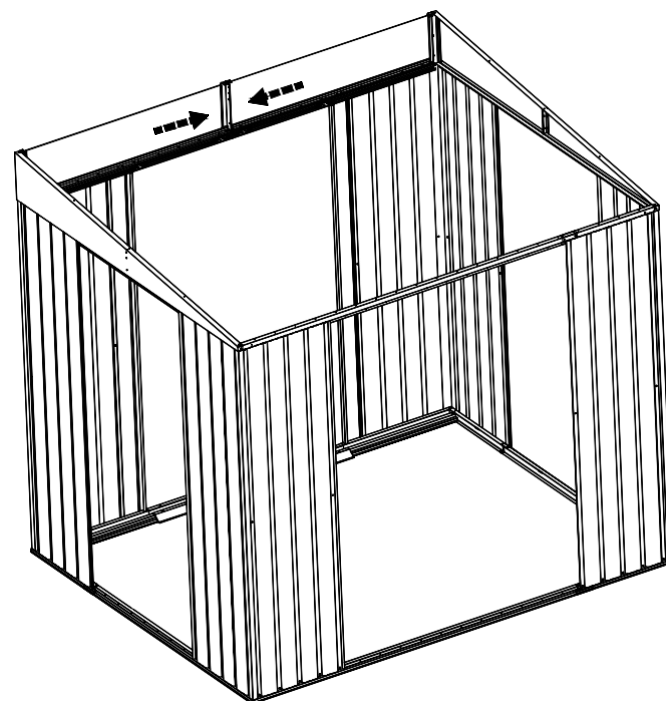
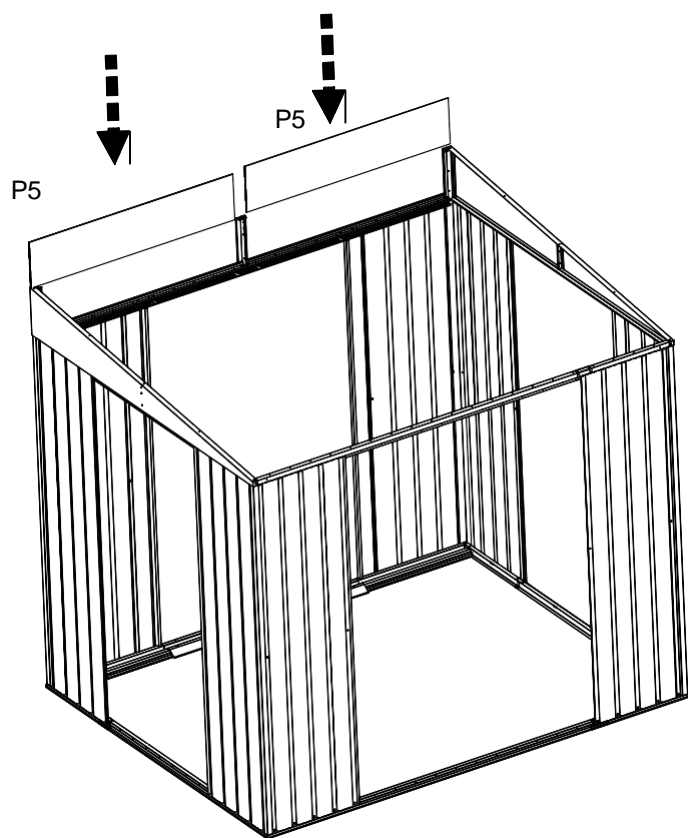

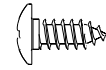

F1 x 20

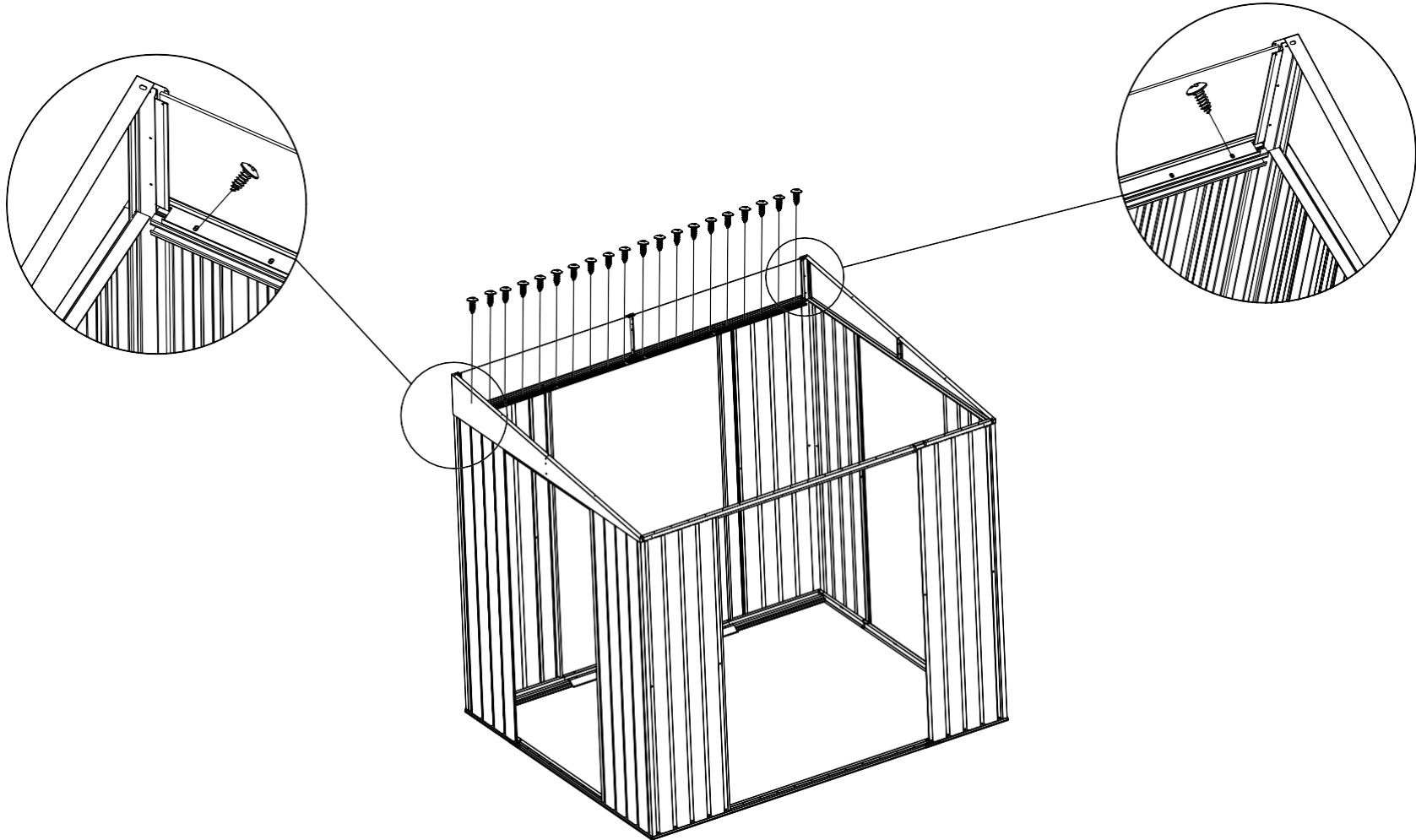

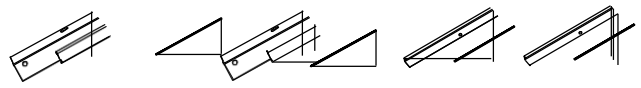

12Lx1

12Rx1

14Lx1

14Rx1

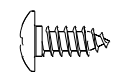

F1 x 12

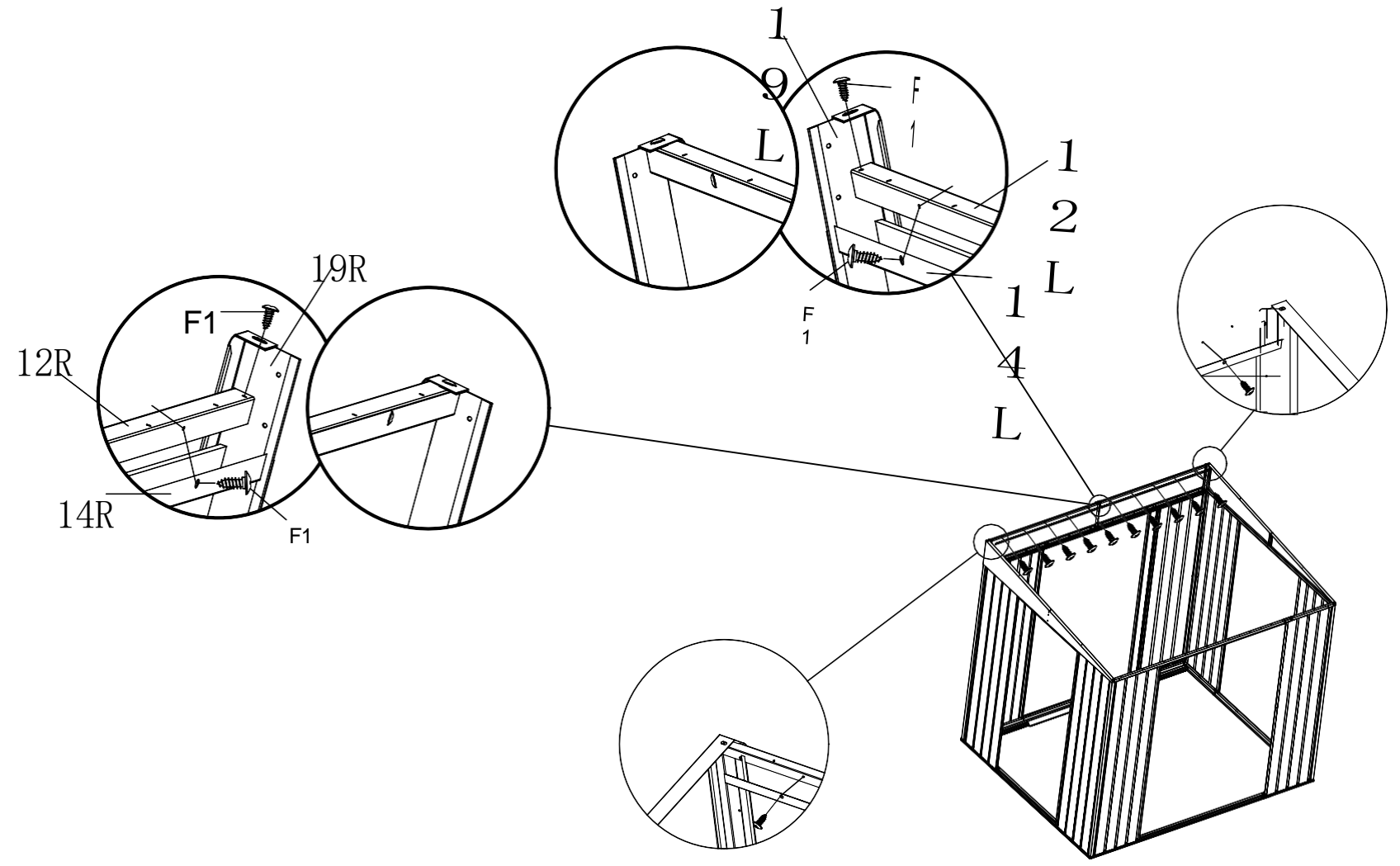

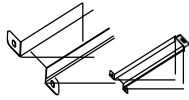

22 x 2

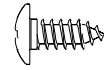

F1 x 6

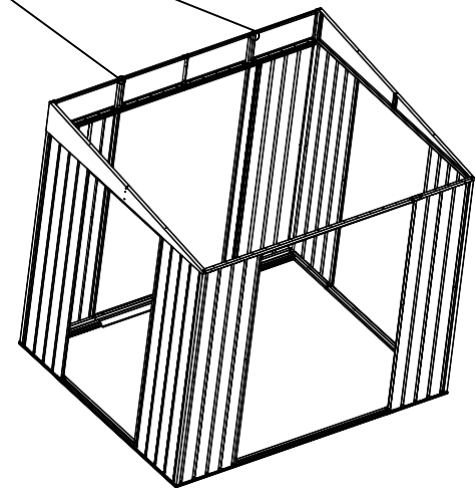
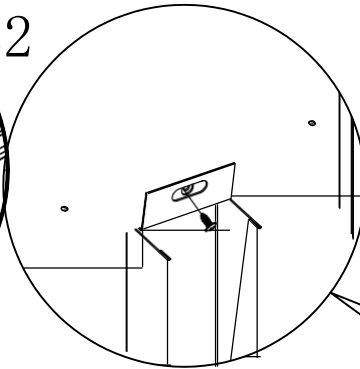
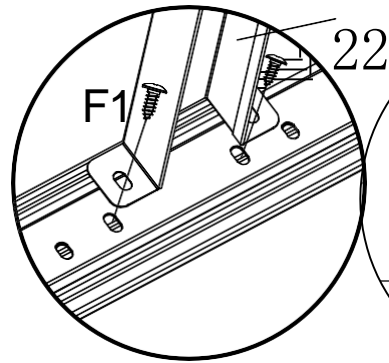

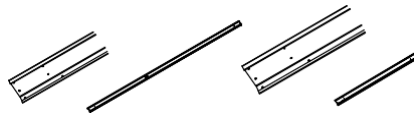

11x1

11-1 x1

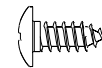

F1 x 14



S3 x 6

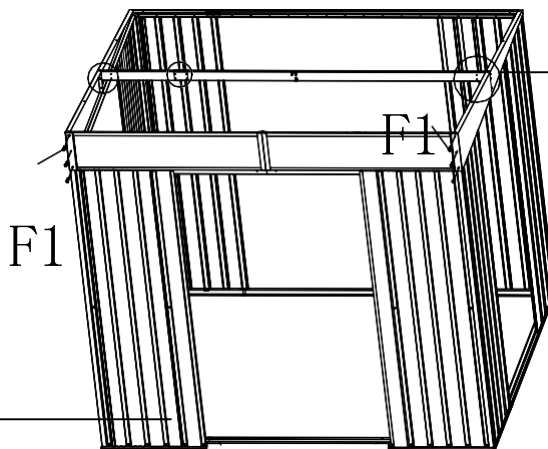
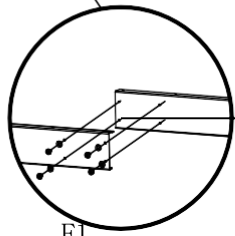
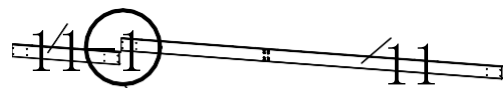
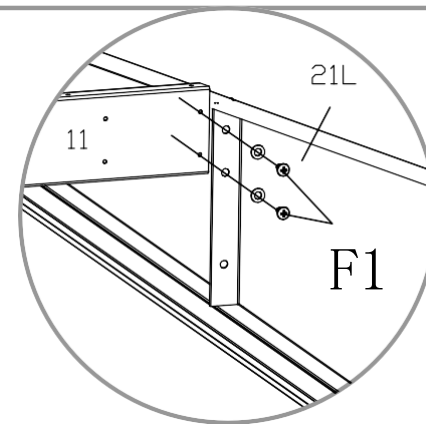
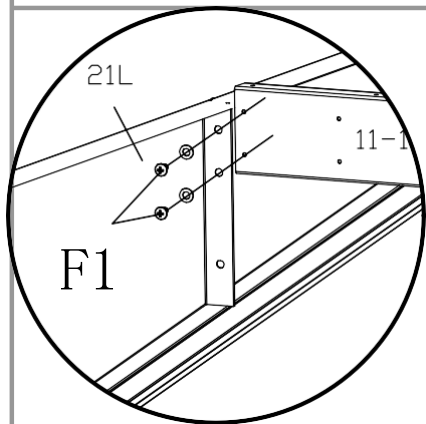

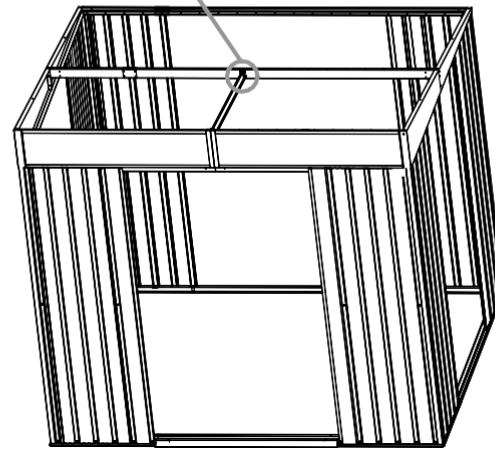
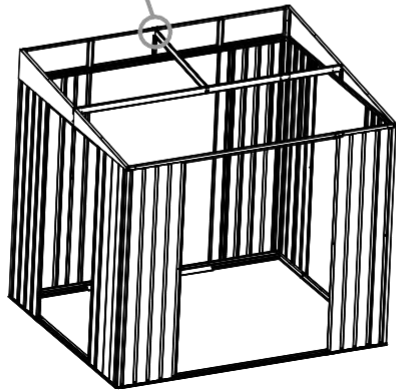
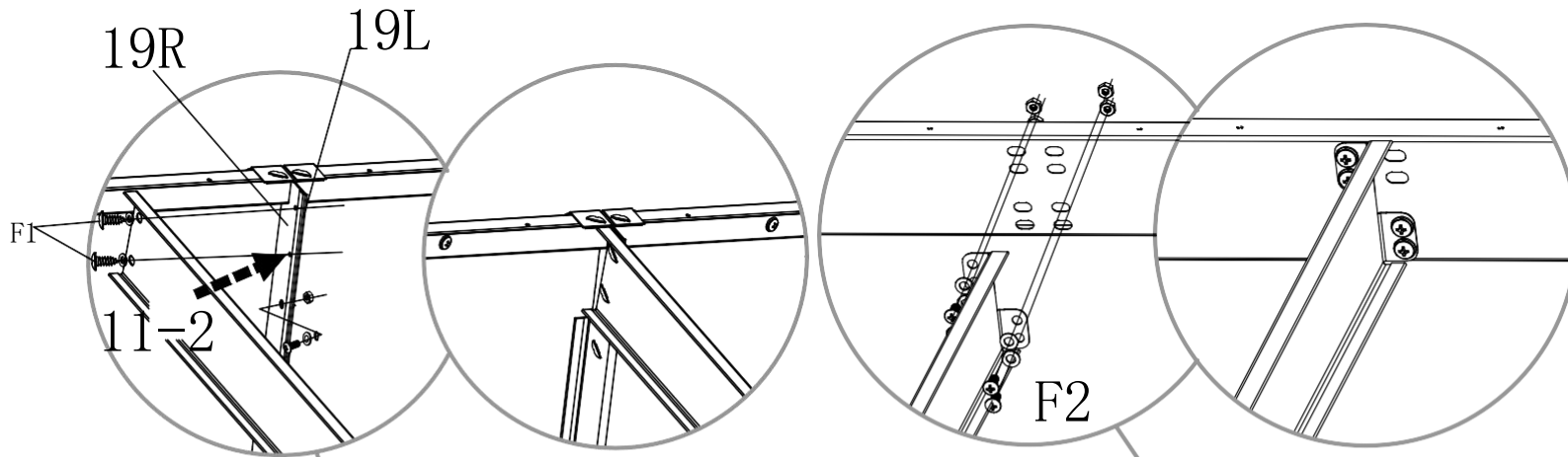
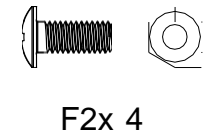
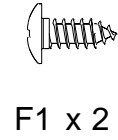
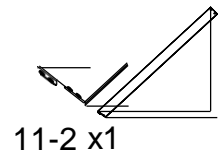

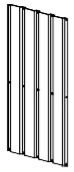

P1 x 7

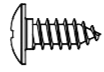

F1x62



F2x 10



S3 x 72

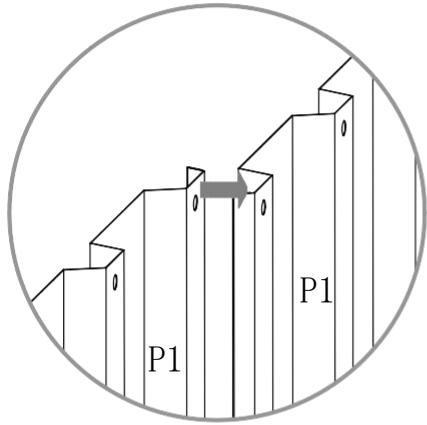

P1

P1

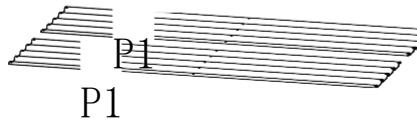

P1

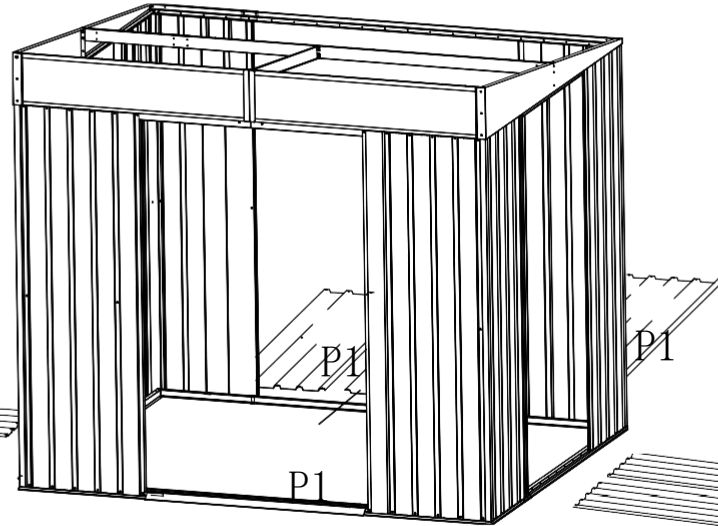

P1

P1

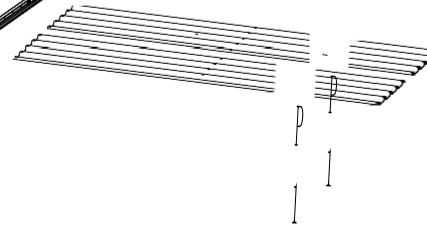

P1

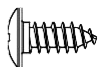
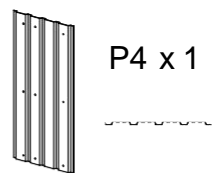
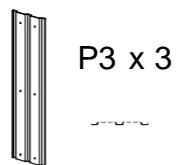
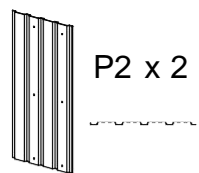

F1x 46

S3 x 46

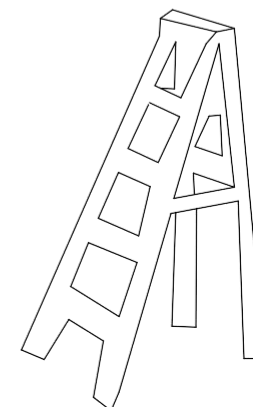
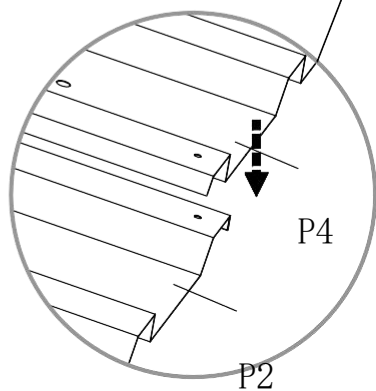
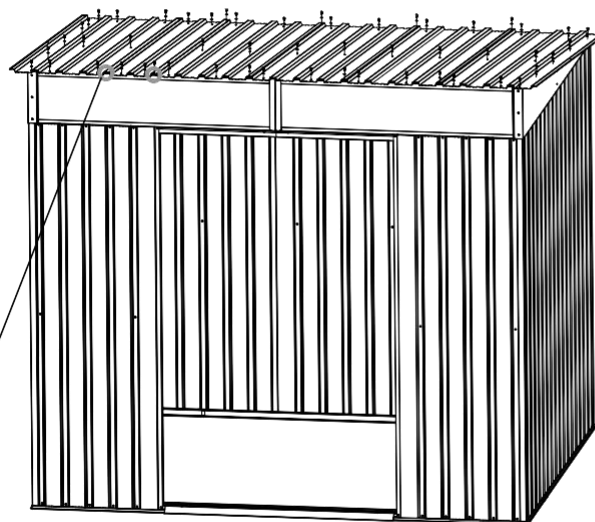
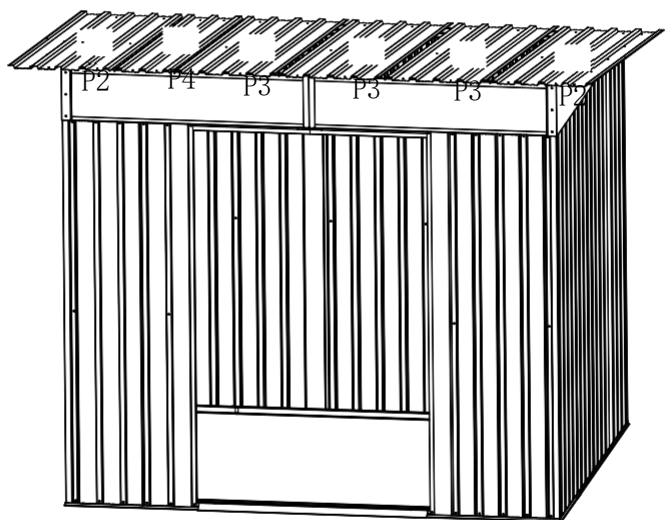

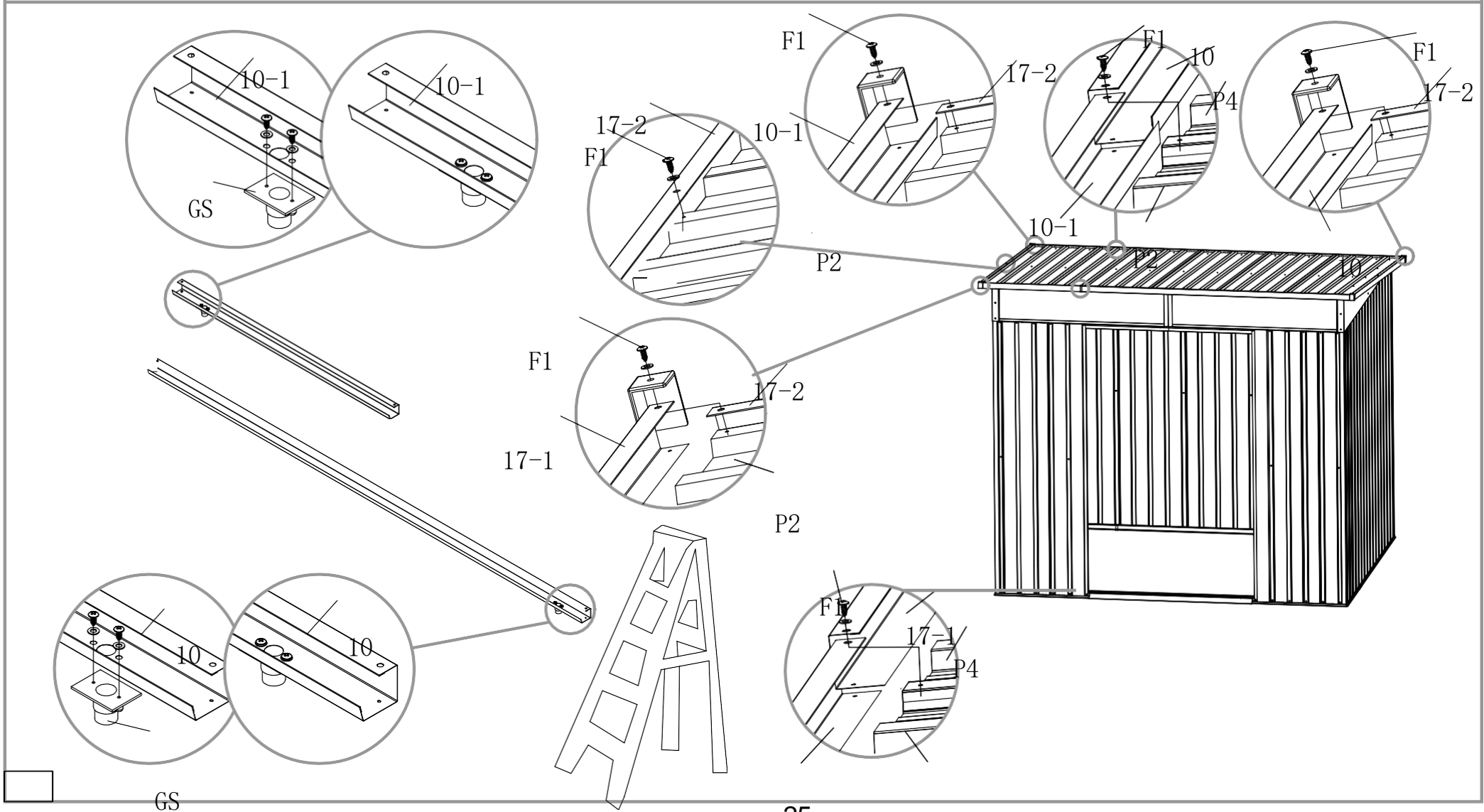
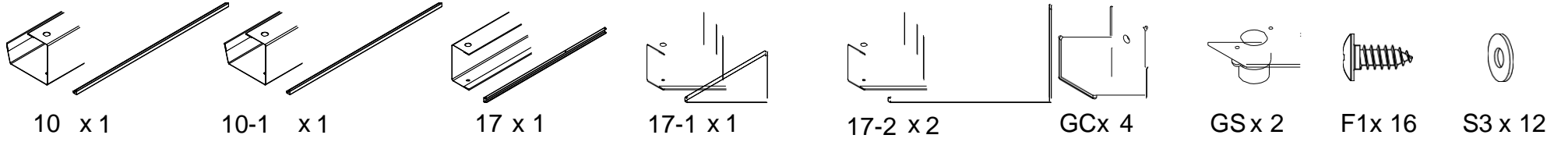



D1X1



D2X1

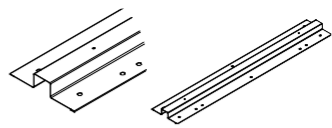

18 x 6

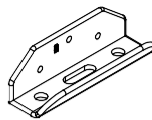

GBx 2

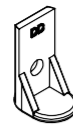

GDx 4

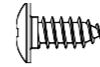

F1x 12

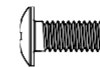

F2x 22



S3x 16

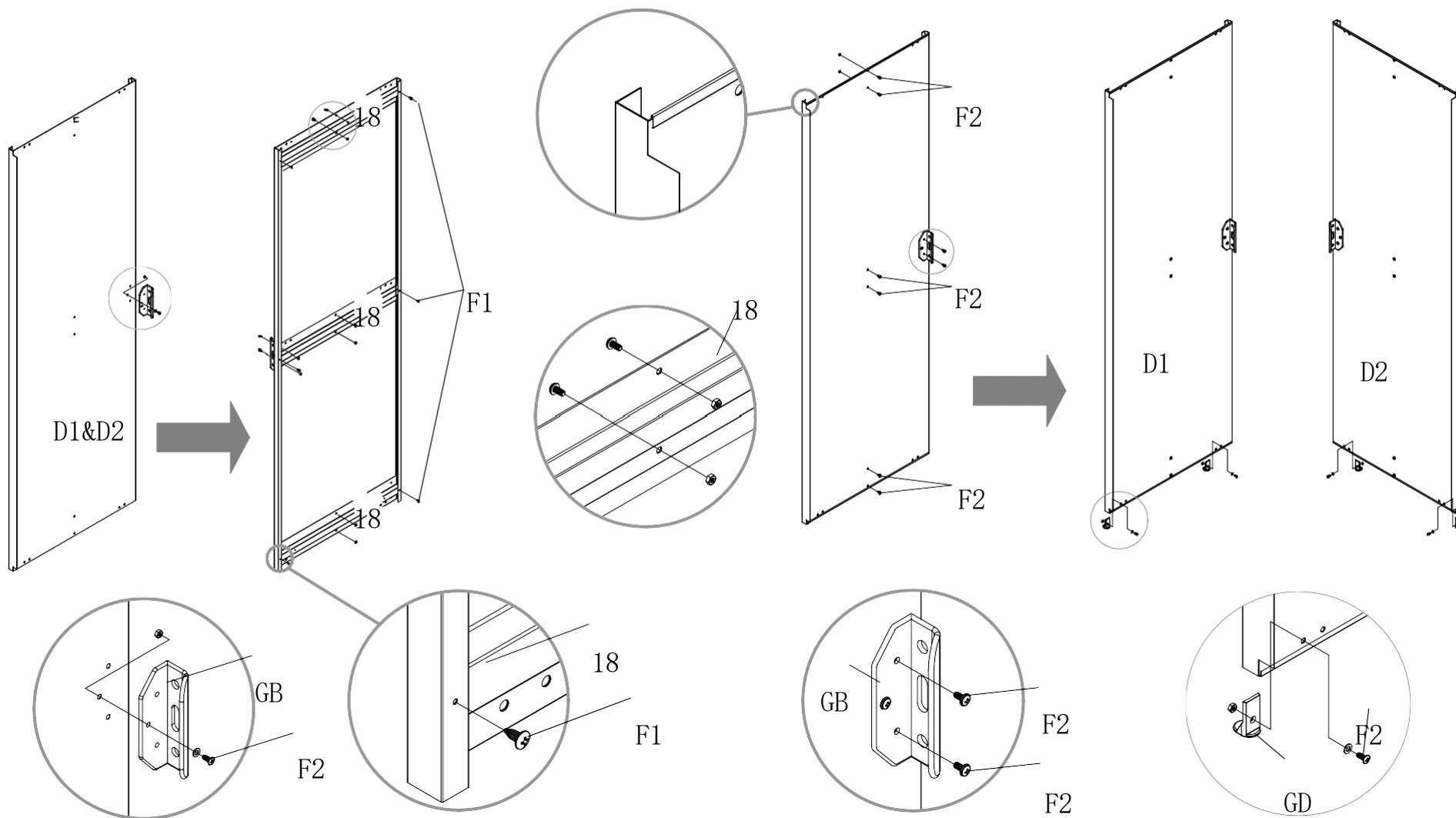

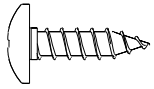

F3x 8

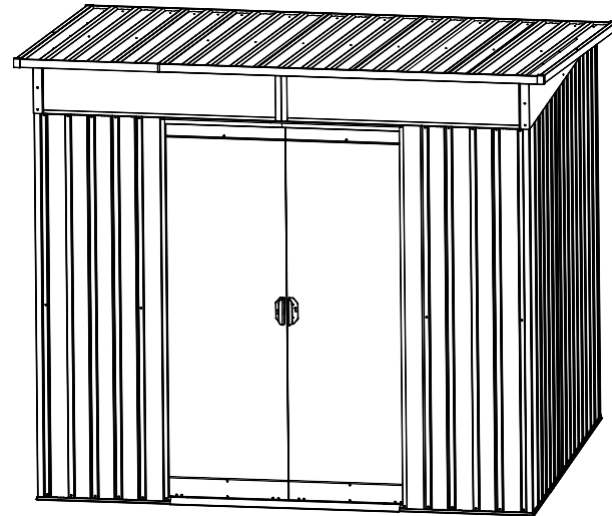
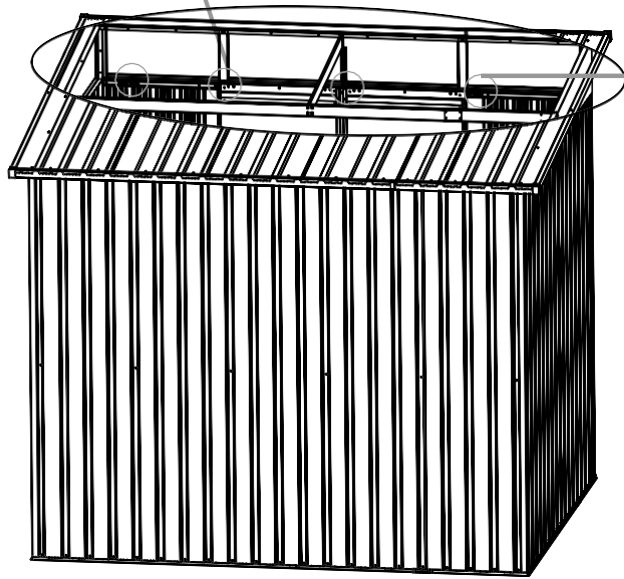
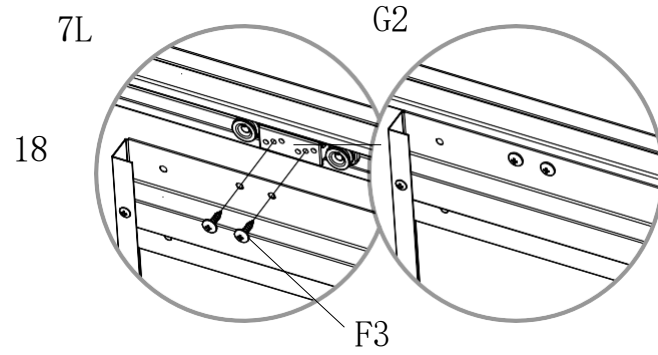
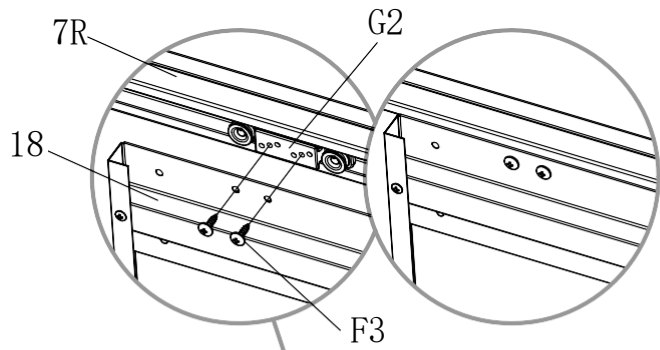

**importer / dovozce:
IPRICE RECARE s.r.o.
Rybníky IV 326
760 01 Zlín
Czechia
tel:420 511 447 788
email:iprice@iprice.cz**